

Elemente feronerie:

CONFIRMATOR 50mm Co 	8	TALPA USA PISTON TU 	1	SURUB 3.5X30 S6 	8	SURUB M4X22 Sm 	2
PISTON Ps 	1	BALAMALE APLICATE Ba 	2	SURUB 3.5X16 S3 	20	COLTAR PLASTIC PVC ALB Cp 	2
CUIE Cu 	18	MANER Mn 	1	TALPA LATERALA PISTON TL 	1		

Pasul 1 (Montaj Accesoriu Lateral)

Se prinde pe placa (2) - 1buc x (TL) cu ajutorul suruburilor (S3) 3.5x16 ca si in imagine.

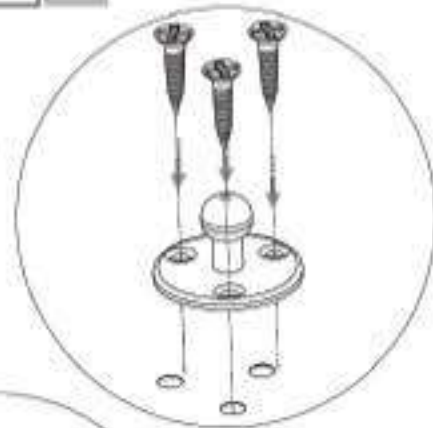
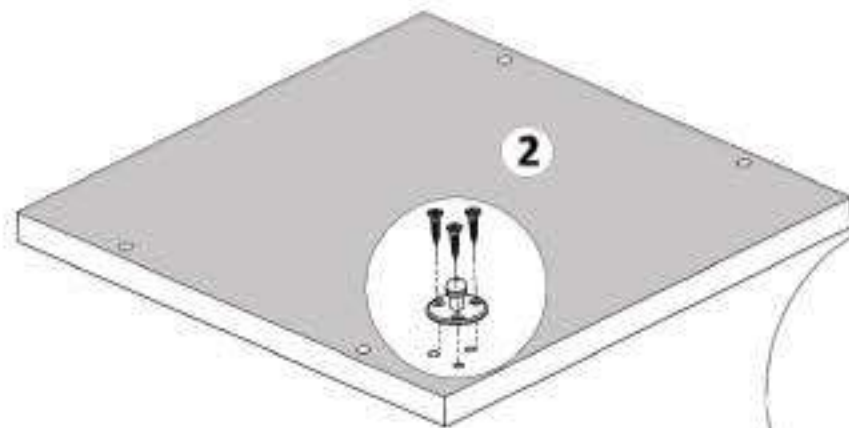

Pasul 2 (Montaj Laterale)

Se prind placile (1) si (2) de placile (3) si (4) cu ajutorul celor 8 x Confirmatoare (Co).

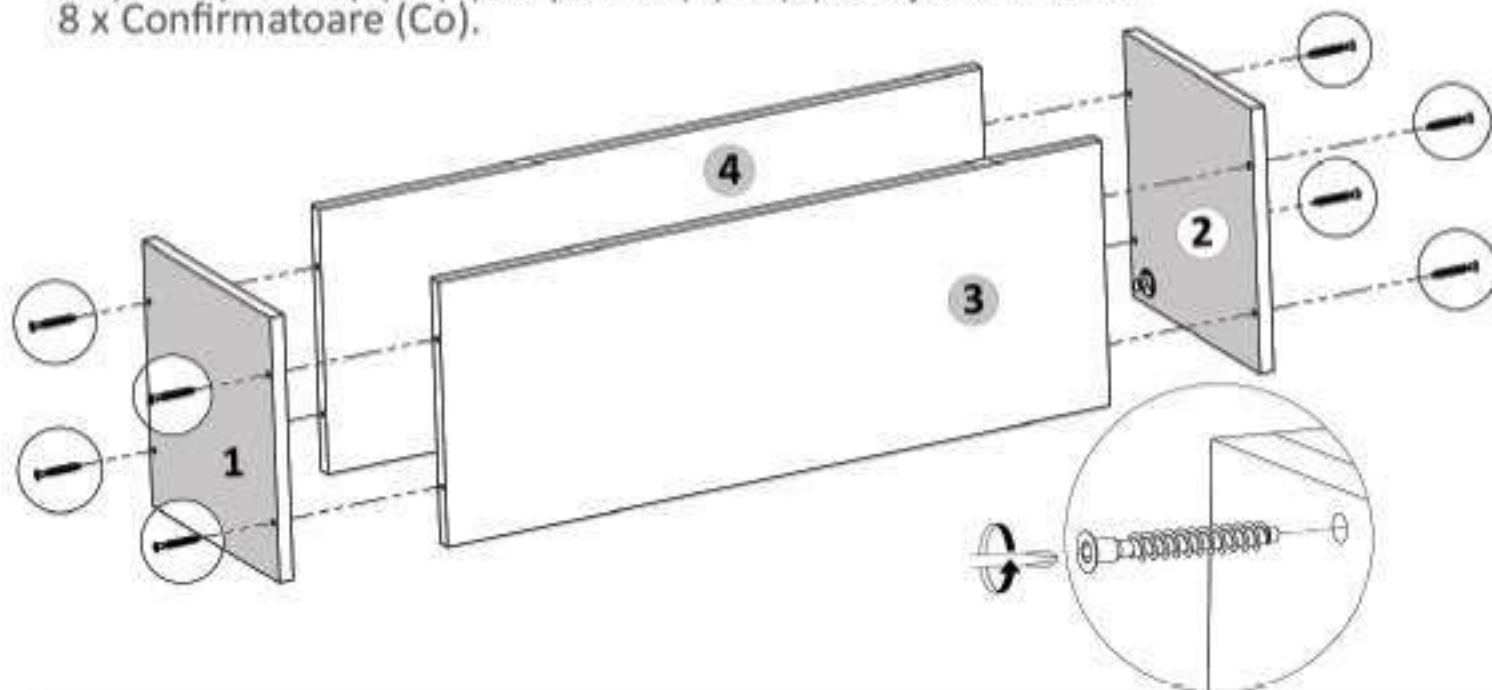

Pasul 3 (Montaj HDF)

Se masoara diagonalele sa fie in vinclu, dupa care se prinde HDF-ul (5) folosindu-se de ciocan cu ajutorul unor cui (Cu) x 18 buc.

 Se masoara diagonalele sa fie in vinclu inainte de a monta HDF-ul!

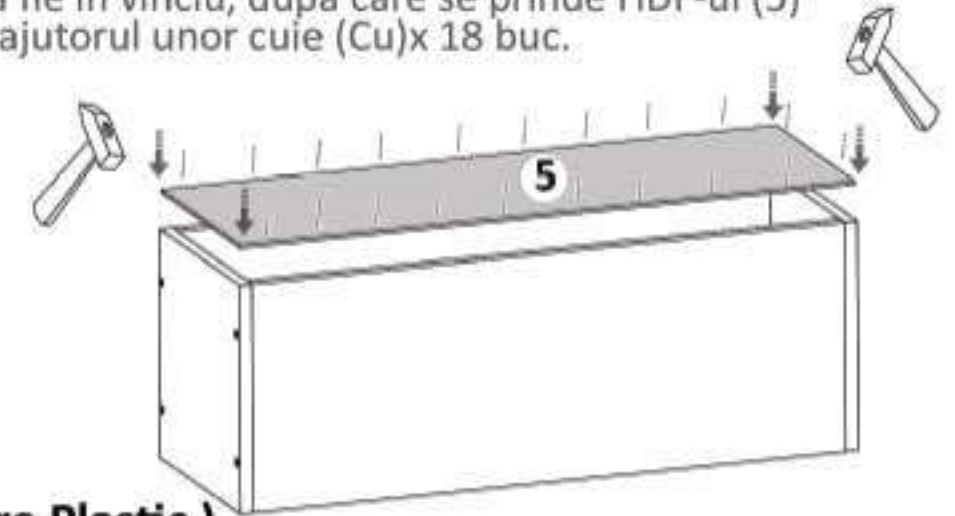

Pasul 4 (Montaj Coltare Plastic)

Se monteaza pe lateralele (1) si (2), 2x Coltare Plastic (Cp) folosindu-se suruburi 3.5x16 (S3) - cate 2 / coltar.

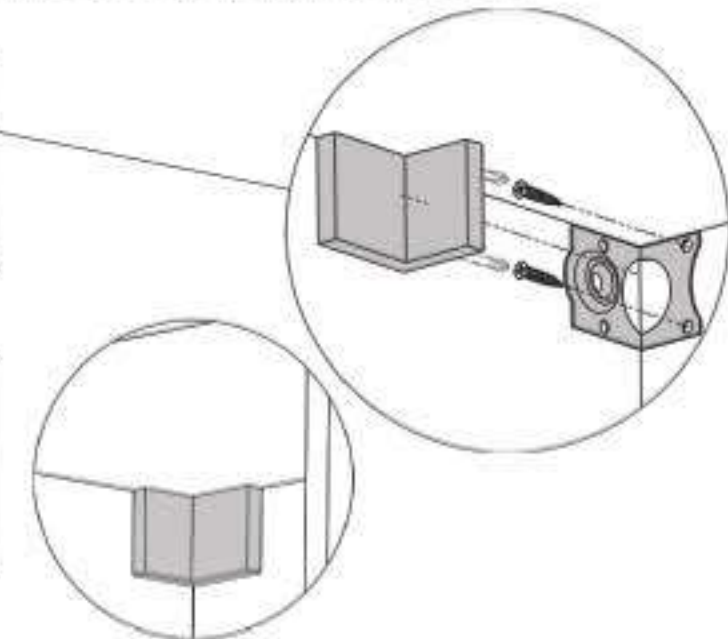
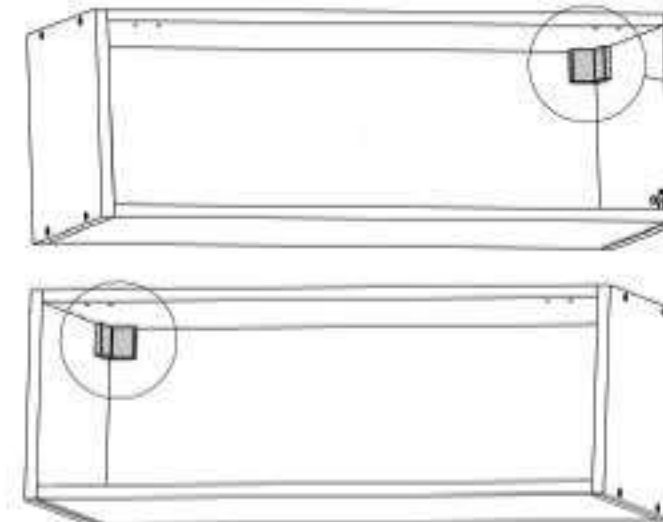

Pasul 5 (Montaj Accesoriu pe Usi)

Se monteaza pe frontul (6) 1x (Tu) pe usa positionat ca si in imagine si montat in gaurile prevazute pt. acestea, urmand a se monta pistonul pe acesta.

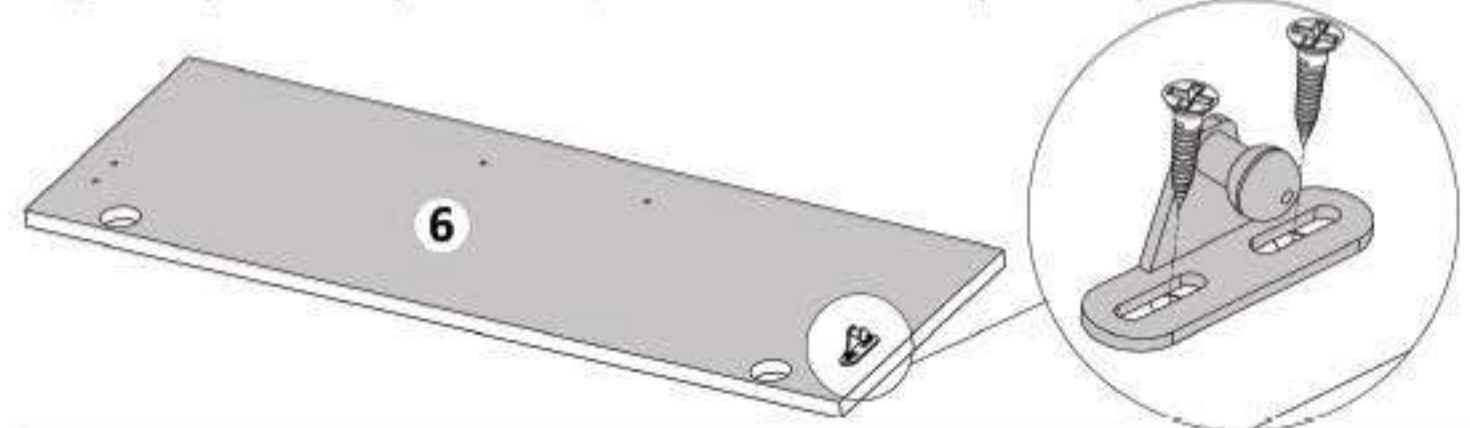

Pasul 6 (Montaj Balamale)

Se monteaza pe placa Front (6) si pe placa (3) balamale (Ba) folosindu-se suruburi 3,5x16 (S8) - cate 4 / balama.

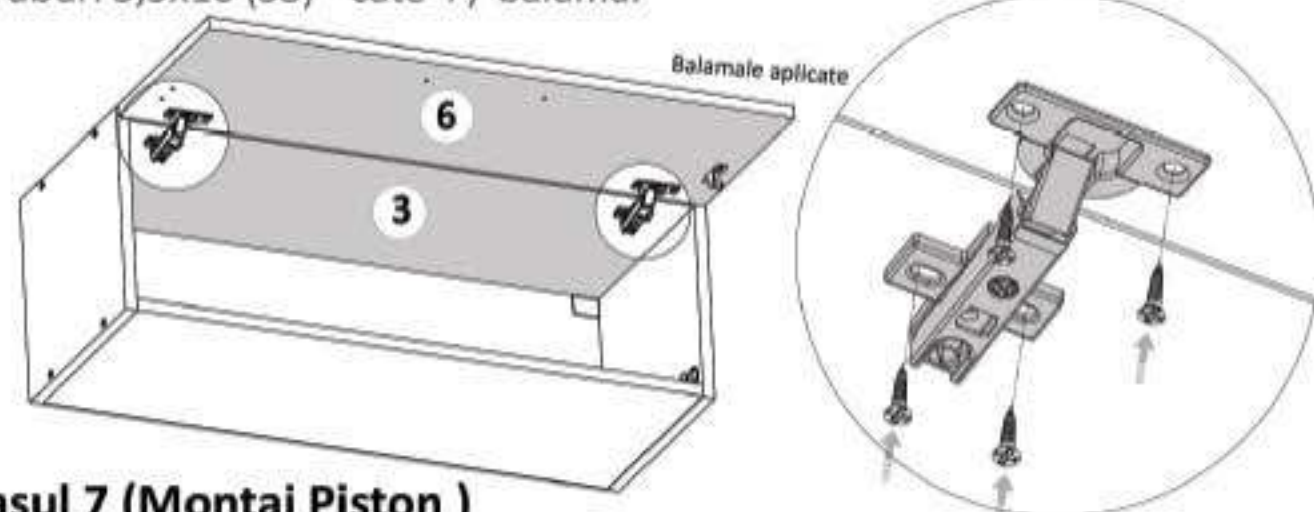

Pasul 7 (Montaj Piston)

Se monteaza pistonul (Ps) 1 x Piston prin introducerea acestuia in accesoriile (TL) si (Tu) pozitionate pe usa si laterala.

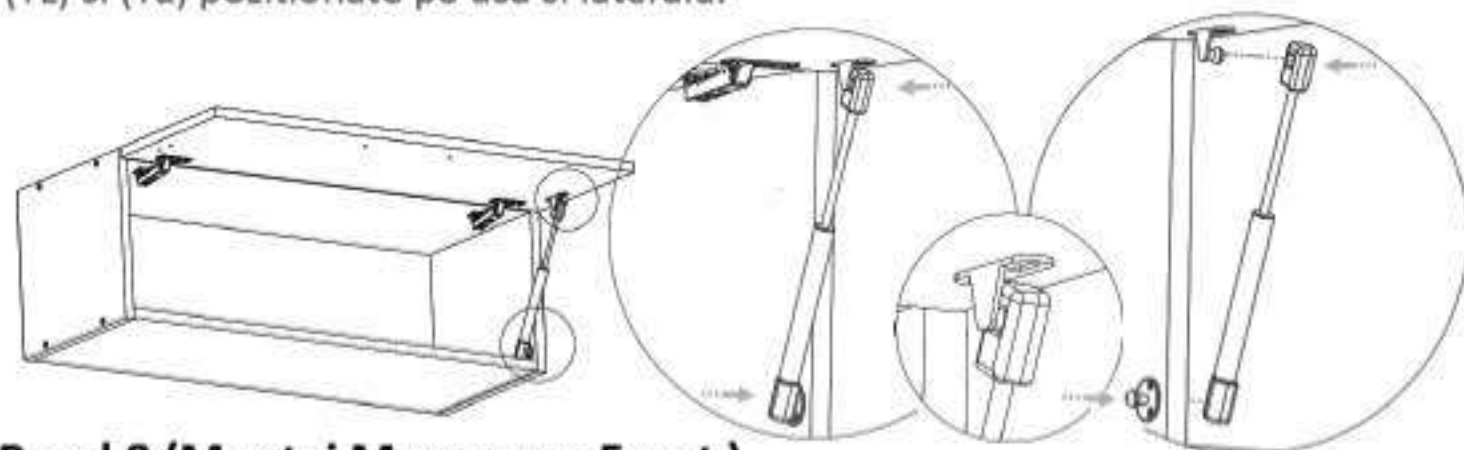

Pasul 8 (Montaj Manere pe Front)

Se monteaza pe placile usa (6) 1x maner (Mn) folosindu-se suruburi M4x22 (Sm) - cate 2 / maner .



Instrucțiuni montaj: Corp Superior Suprapus Orizontal 600 mm

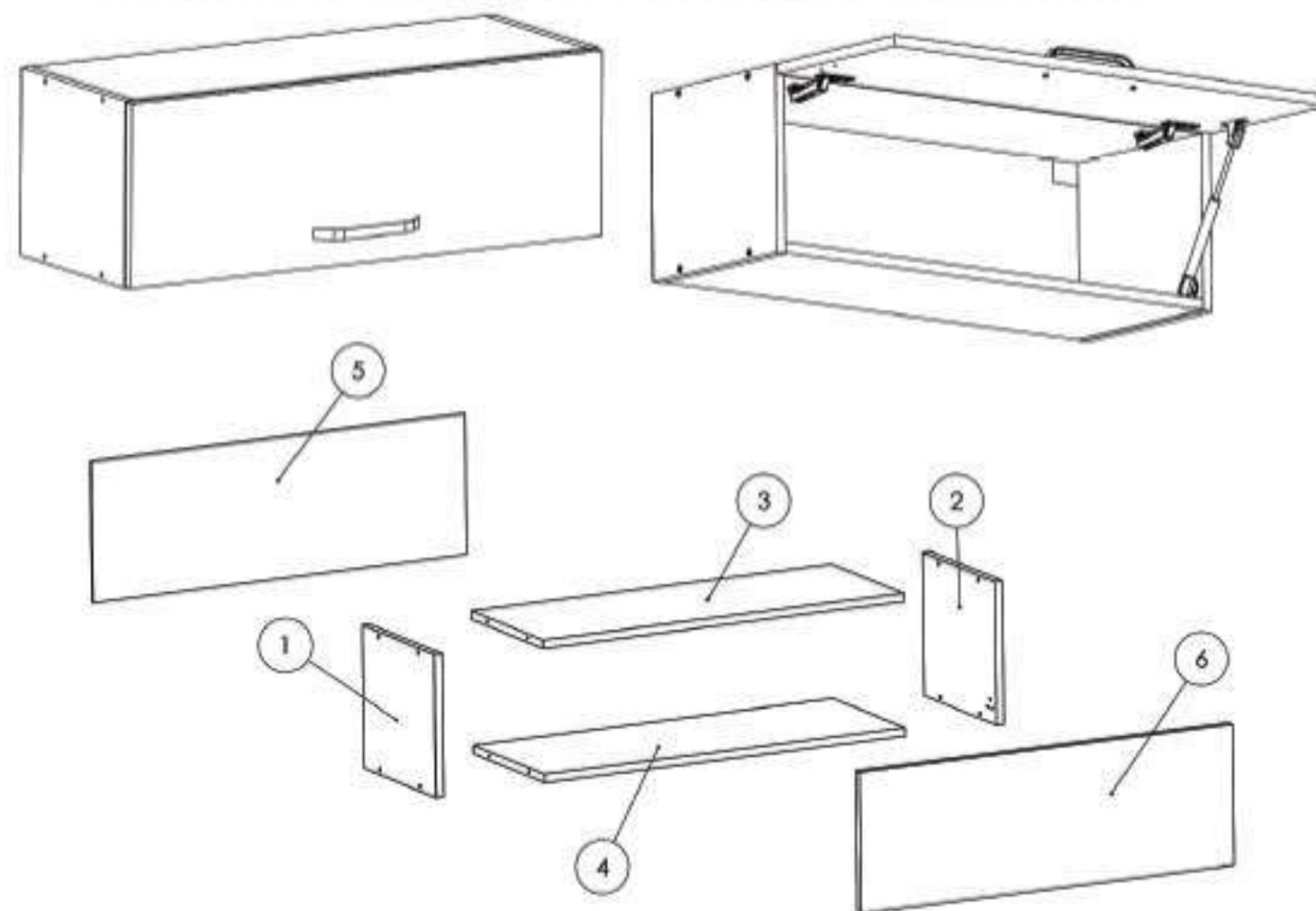

NR. REPER	COD REPER	DETALII	CANTITATE
1	LATERALA ST.	PAL 287X275X16	1
2	LATERALA DR.	PAL 287X275X16	1
3	TAVAN	PAL 566X287X16	1
4	FUND	PAL 566X287X16	1
5	HDF	HDF 594X271X4	1
6	FRONT	PAL 594X271X16	1

ATENȚIE: MONTAJUL NECORESPUNZĂTOR ATRAGE DUPĂ SINE PIERDEREA GARANȚIEI PRODUSULUI



Șurubelniță în cruce sau autofiletantă



Este recomandat ca montajul să fie făcut de minim două persoane



Un ciocan de dimensiune medie