

**Nu te descurci ?**  
 Acceseaza site-ul companiei  
 sau **scaneaza codul QR** pentru  
 instructiuni si video-uri cu montaj

**Nu te descurci ?**  
 Acceseaza site-ul companiei  
 sau **scaneaza codul QR** pentru  
 instructiuni si video-uri cu montaj

### Pasul 6 (Montaj Balamale)

Se monteaza pe placa Front (6) si pe placile (2) respectiv (3) balamale (Ba) si (Bs) folosindu-se suruburi 3,5x16 (S8) .

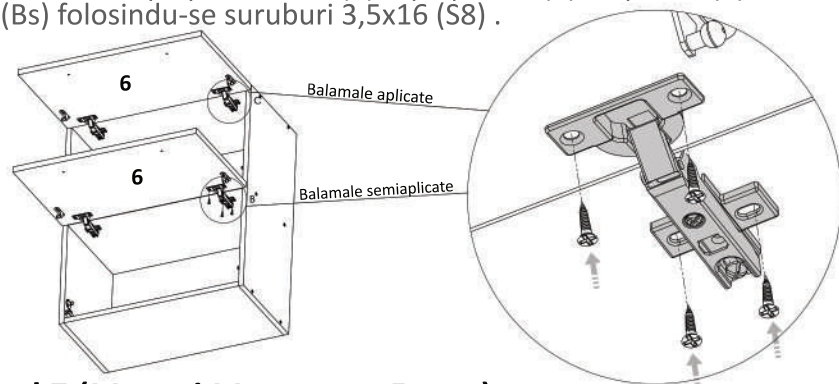

### Pasul 7 (Montaj Manere pe Front)

Se monteaza pe placile usa (6) 2x maner mare folosindu-se suruburi M4x22 (Sm) - cate 2 / maner .

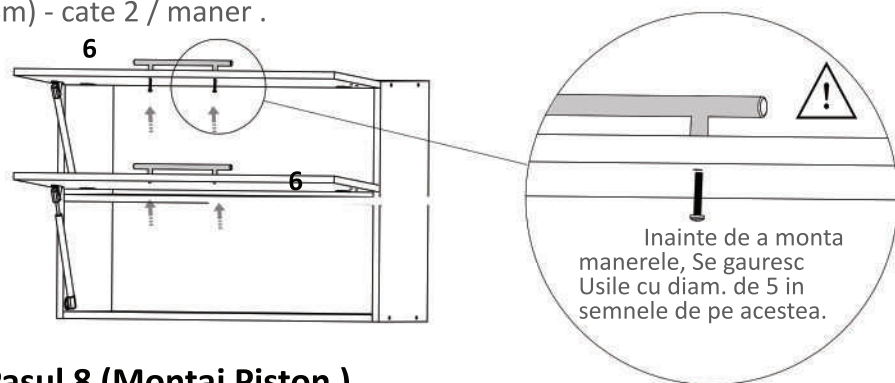

### Pasul 8 (Montaj Piston)

Se monteaza pistonul (Ps) 2x piston prin introducerea acestuia in acesoriile (TL) si (Tu) pozitionate pe usi si laterale.

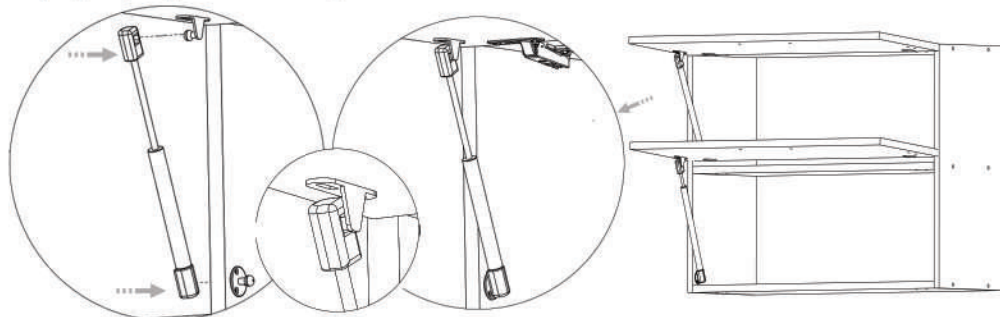

### Instructiuni montaj: Corp Superior Orizontal 600 mm

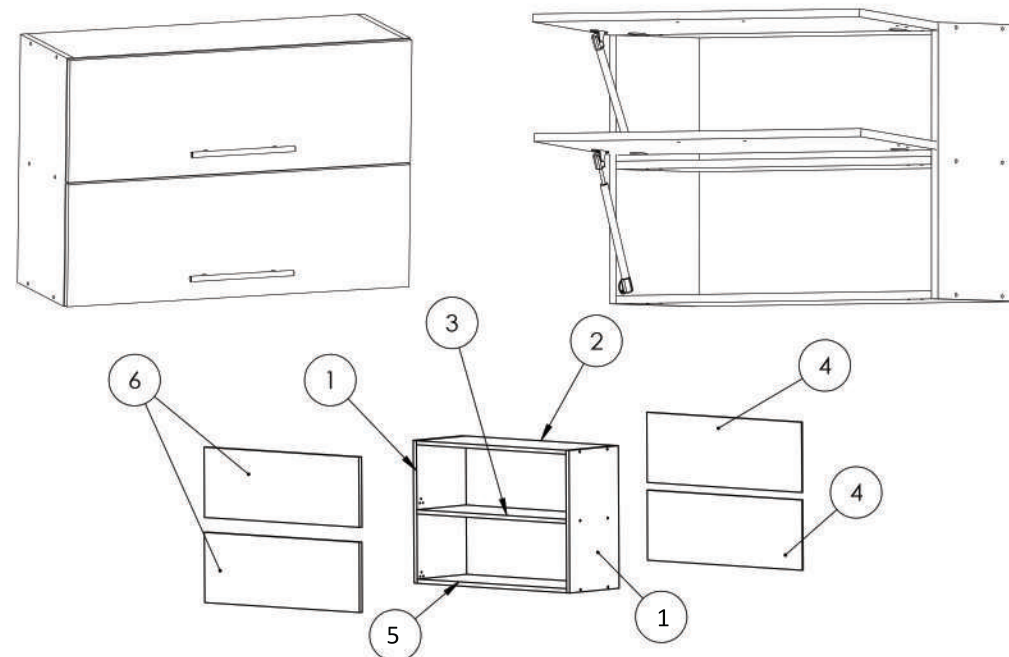

NR.REPER	COD REPER	DETALII	CANTITATE
1	LATERALE ST/DR	PAL 550X287X16	2
2	TAVAN	PAL 566X287X16	1
3	POLITA FIXA	PAL 566X287X16	1
4	HDF	HDF 594X271X2,5	2
5	FUND	PAL 566X287X16	1
6	USA ORIZONTALA	PAL 594X271X16	2

ATENȚIE: MONTAJUL NECORESPUNZĂTOR ATRAGE DUPĂ SINE PIERDEREA GARANȚIEI PRODUSULUI



Șurubelniță în cruce  
sau autofiletantă



Este **recomandat** ca  
montajul să fie făcut de  
minim două persoane













Un **ciocan** de dimensiune  
medie

**Nu te descurci ?**  
 Acceseaza site-ul companiei  
 sau **scaneaza codul QR** pentru  
 instructiuni si video-uri cu montaj

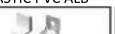
**Nu te descurci ?**  
 Acceseaza site-ul companiei  
 sau **scaneaza codul QR** pentru  
 instructiuni si video-uri cu montaj

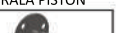
### Elemente feronerie:

CONFIRMATOR 50mm <b>Co</b>	 12	TALPA USA PISTON <b>TU</b>	 2	SURUB 3.5X30 <b>S6</b>	 8	SURUB M4X22 <b>Sm</b>	 4
SAIBE TIP CUPA <b>Sc</b>	 5	BALAMALE APLICATE <b>Ba</b>	 2	SURUB 3.5X16 <b>S3</b>	 30	COLTAR PLASTIC PVC ALB <b>Cp</b>	 2
CUIE <b>Cu</b>	 35	BALAMALE SEMIAPPLICATE <b>Bs</b>	 2	TALPA LATERALA PISTON <b>TL</b>	 2	PISTON <b>Ps</b>	 2

### Pasul 1 (Montaj Accesoriu Lateral)

Se prinde pe placa (1) - 2buc x (TL)  
 cu ajutorul suruburilor (S3) 3.5x16 ca si in imagine.

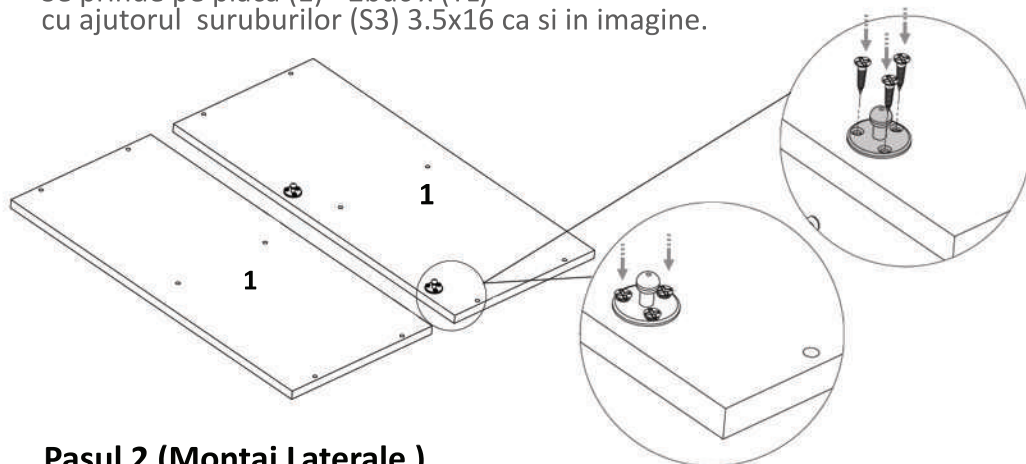

### Pasul 2 (Montaj Laterale)

Se prind placile (1) de placile (2) (3) si (5) cu ajutorul celor 12 x Confirmatoare (Co)

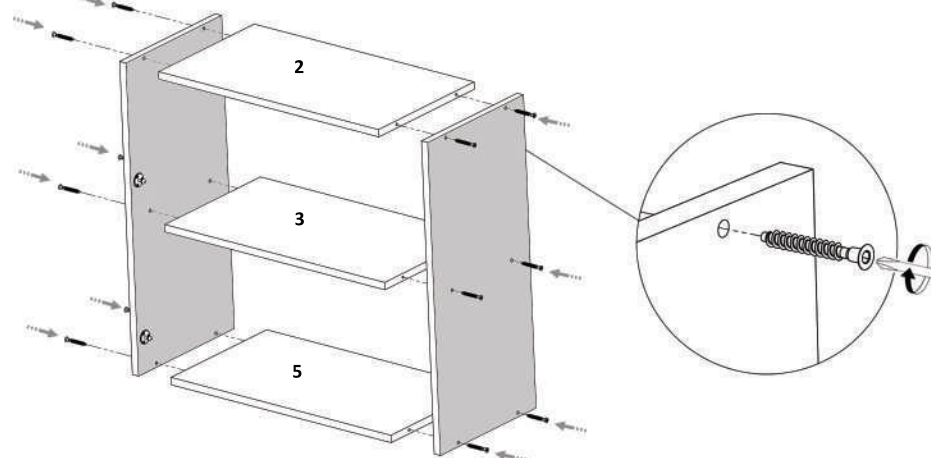

### Pasul 3 (Montaj HDF)

Se masoara diagonalele sa fie in vinclu, dupa care se prinde HDF-ul (4) folosindu-se de ciocan cu ajutorul unor cuie (Cu) x 45 buc, iar pe mijloc se folosesc saibe tip cupa (Sc) x 10buc.

   
 Se masoara diagonalele sa fie in vinclu inainte de a monta HDF-ul!

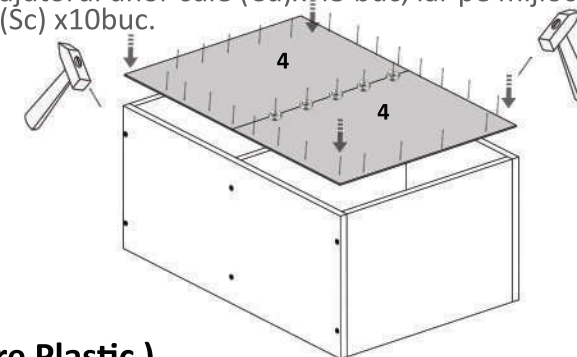

### Pasul 4 (Montaj Coltare Plastic)

Se monteaza pe lateralele (1), 2x Coltare Plastic (Cp) folosindu-se suruburi 3.5x16 (S3) - cate 2 / coltar.

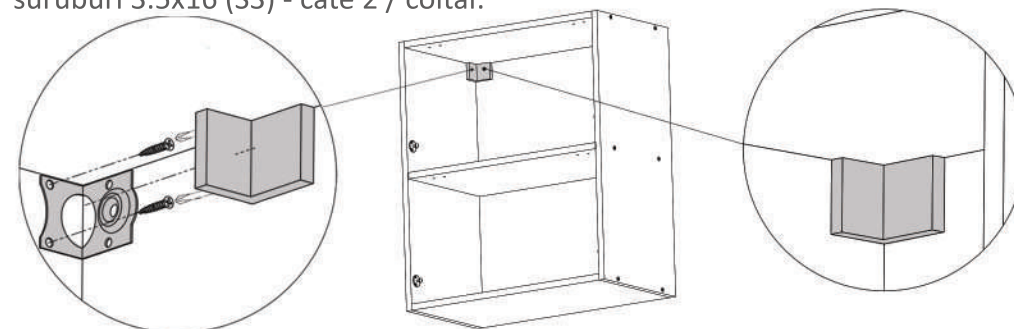

### Pasul 5 (Montaj Accesoriu pe Usi)

Se monteaza pe fronturile (6) cate 2x (Tu) pe fiecare usa positionate ca si in imagine si montate in gaurile prevazute pt. acestea, urmand a se monta pistonul pe acestea.

