

COMODA TV

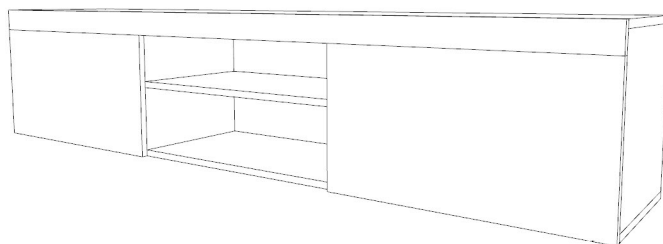

RO INSTRUCTIUNI DE MONTAJ
EN INSTALLATION INSTRUCTIONS
DE INSTALLATIONSANLEITUNG
FR INSTRUCTIONS D'INSTALLATION
IT ISTRUZIONI PER L'INSTALLAZIONE
HU SZERELÉSI ÚTMUTATÓ
UKR ІНСТРУКЦІЯ ПО МОНТАЖУ
SRB УПУТСТВО ЗА ИНСТАЛАЦИЈУ
BG ИНСТРУКЦИЈ ЗА ИНСТАЛИРАНЕ
RUS ИНСТРУКЦИЈА ПО МОНТАЖУ



Denumire	Dimensiune	Bucati	Simbol
Tavan	1800 336	1	T
Fund	1800 336	1	F
Laterale	348 336	2	L
Lezana	1800 60	1	LZ
Polite	600 336	1	P
Intermediare	348 336	2	IM
Front	600 316	2	F

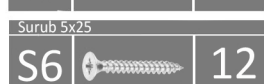
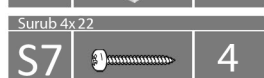
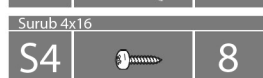
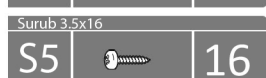
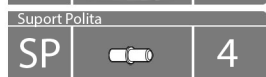
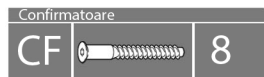
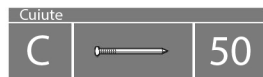

1 Montare

Se prind lateralele si intermediarele de capacul de jos al dulapului.

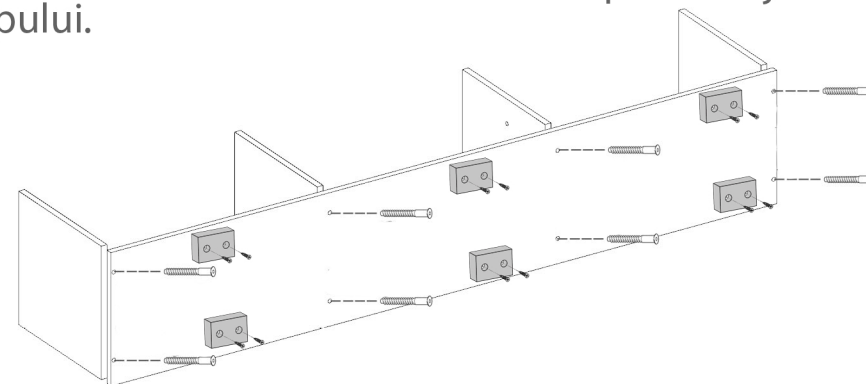

Picioarele de plastic gri (Pi) x 6buc se monteaza pe placa Fund (F) cu suruburi (S6) x 12 buc - cate 2 / picior.

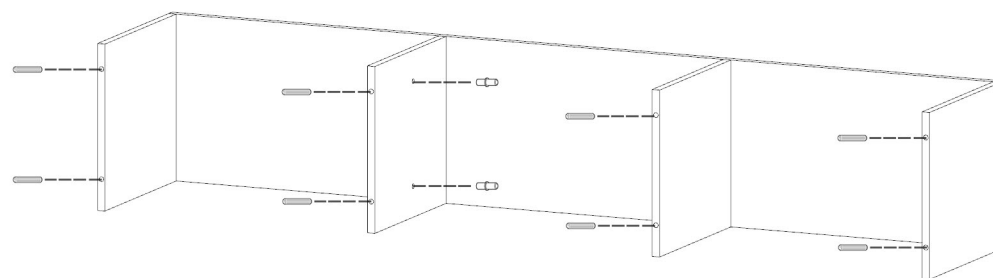

Pentru a prinde tavanul, vom folosi cepi de lemn, acestia se vor bate usor in laterale si intermediare.

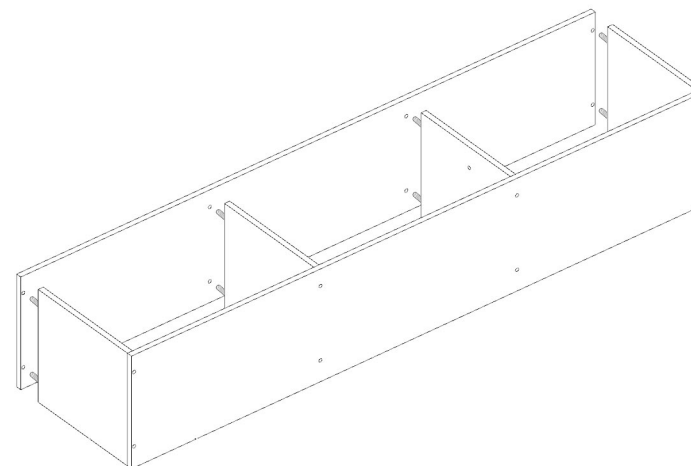

COMODA TV

2 Montare HDF

Important! Inainte de a prinde HDF-ul de partea din spate a dulapului, acesta trebuie adus in vinclu, adica la 90 de grade.
Se va intoarce dulapul cu cantul spre podea, va ramane in pozitie orizontala, apoi se va prinde HDF-ul cu cuiute (C).

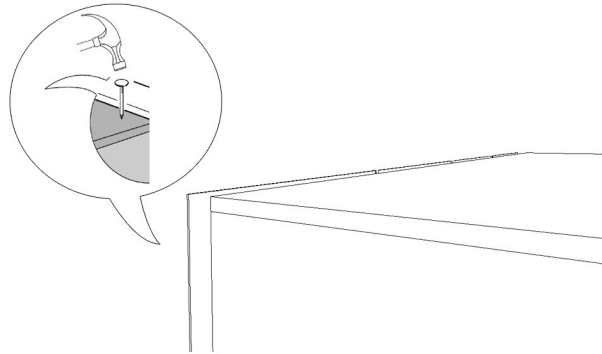

Dupa prinderea HDF-ului, se aseaza politele mobile pe suporti de polita (SP).

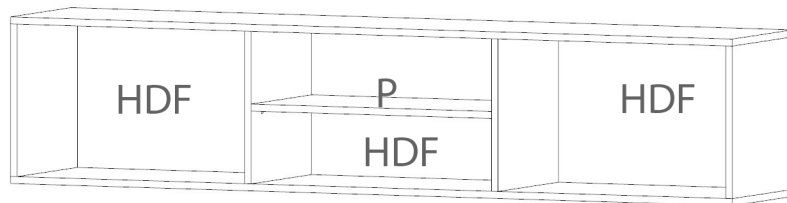

3 Montare lezene si front

Lezena se monteaza cu ajutorul coltarelor de plastic (CP) care se prind din interiorul dulapului.
Coltarele de plastic se vor prinde de tavan si de lezena cu surub 4x16(S4).

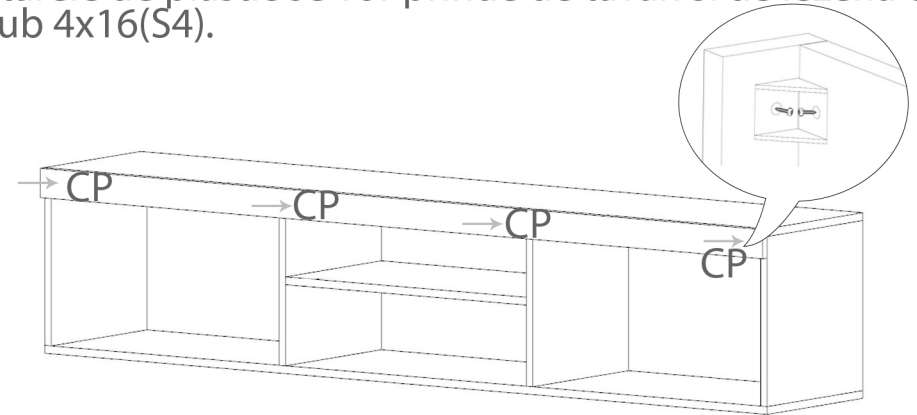

Prinderea balamalelor pe usi se face ca in desenul de mai jos.
Pentru prinderea balamalelor (BA) se vor folosi suruburile 3.5x16 (S5).

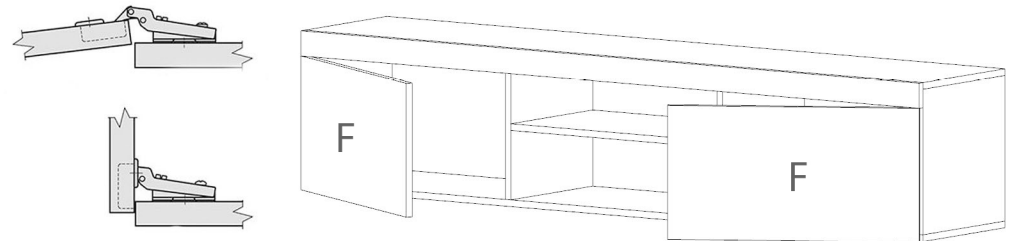

Se regleaza cu ajutorul unei surubelnite PZ2, frontul pentru a fi aliniat.
Manerele (M) se fixeaza pe front cu ajutorul suruburilor S7.