

# CORP INALT

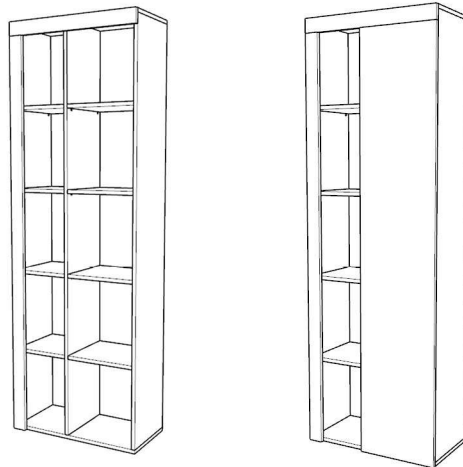

RO INSTRUCTIUNI DE MONTAJ  
EN INSTALLATION INSTRUCTIONS  
DE INSTALLATIONSANLEITUNG  
FR INSTRUCTIONS D'INSTALLATION  
IT ISTRUZIONI PER L'INSTALLAZIONE  
HU SZERELÉSI ÚTMUTATÓ  
UKR ІНСТРУКЦІЯ ПО МОНТАЖУ  
SRB УПУТСТВО ЗА ИНСТАЛАЦИЈУ  
BG ИНСТРУКЦИИ ЗА ИНСТАЛИРАНЕ  
RUS ИНСТРУКЦИЯ ПО МОНТАЖУ



Denumire	Dimensiune	Bucati	Simbol
Tavan	600 288	1	T
Fund	600 288	1	F
Laterale	1768 288	2	L
Lezena 1	600 60	1	LZ
Lezena 2	1740 60	1	LZ
Polite	306 288	4	P
Polite	246 288	4	P
Intermediara	1768 288	1	IM
Front	1736 336	1	F

Picioare plastic gri Pi  4	Cuiute C  66	Confirmatoare CF  12
Support Polita SP  32	Balamale Aplicare BA  3	Coltar Plastic CP  7
Surub 3,5x16 S5  12	Surub 4x16 S4  14	Surub M4x22 S7  2
Saiba Cupa SC  18	Maner M  1	Surub 5x25 S6  8

## 1 Montare

Se fixeaza pe fund cele 3 piese (laterale si intermediara), iar apoi se fixeaza tavanul.

Picioarele de plastic gri (Pi) x 4buc se monteaza pe placa Fund (F) cu suruburi (S6) x 8 buc - cate 2 / picior.

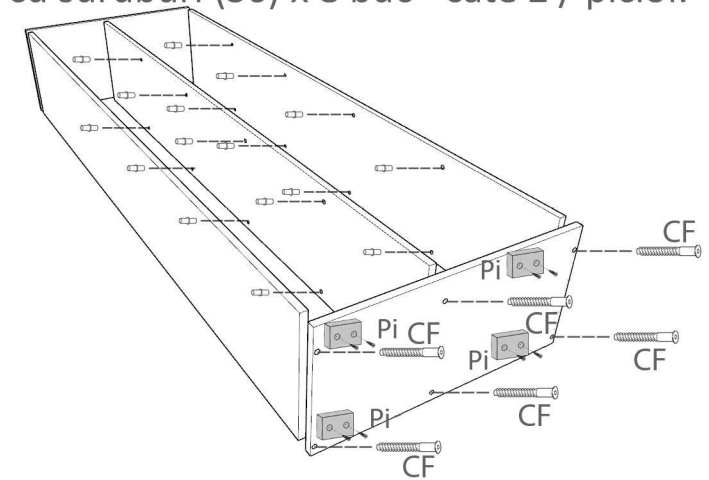

Se monteaza suportii de polita precum este reprezentat in cele doua desene.

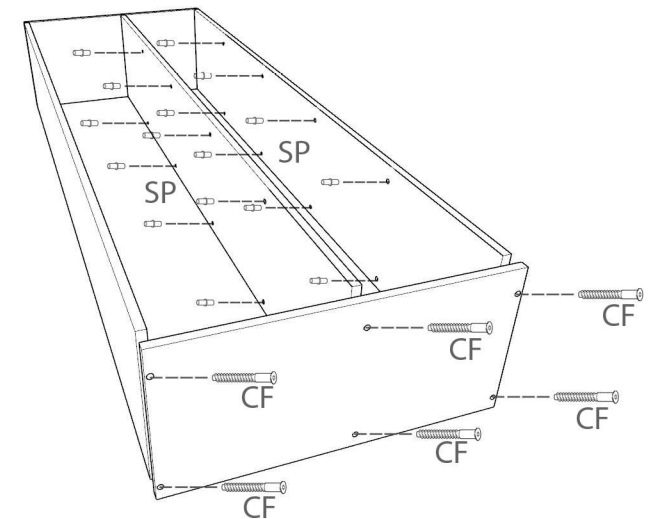

## CORP INALT

### 2 Montare HDF

**Important!** Inainte de a prinde HDF-ul de partea din spate a dulapului, acesta trebuie adus in vinclu, adica la 90 de grade.

Se va intoarce dulapul cu cantul spre podea, va ramane in pozitie orizontala, apoi se va prinde HDF-ul cu cuiute (C) si cu ajutorul saibelor cupa (SC).

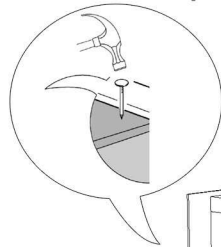
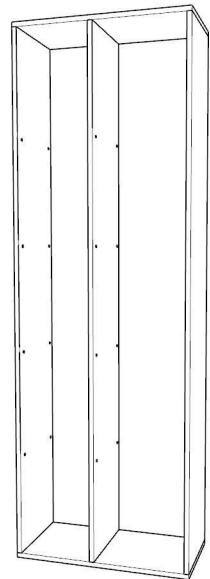

Dupa prinderea HDF-ului, se aseaza politele mobile pe suporti de polita (SP).

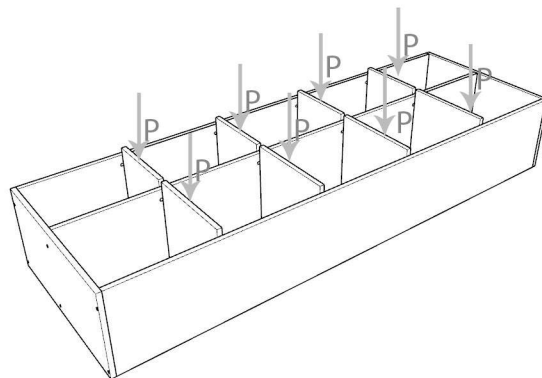

### 3 Montare lezene si front

Lezenele se monteaza cu ajutorul coltarelor de plastic (CP) care se prind din interiorul dulapului. Coltarele de plastic se vor fixa de laterala si lezna cu surub 4x16(S4).

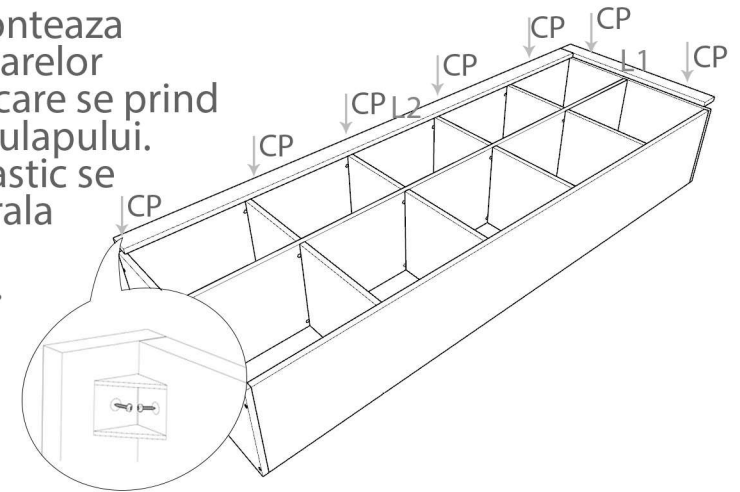

Prinderea balamalelor pe usi se face ca in desenul de mai jos.

Pentru prinderea balamalelor (BA) se vor folosi suruburile 3.5x16 (S5).

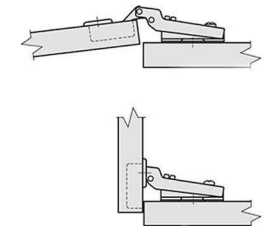
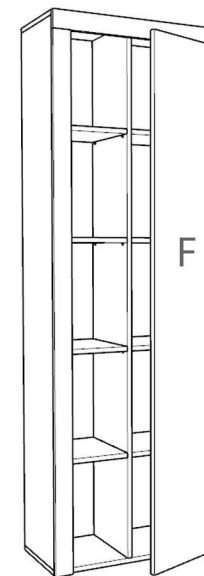

Se regleaza cu ajutorul unei surubelnite PZ2, frontul pentru a fi aliniat. Manerul(M) se fixeaza pe front cu ajutorul suruburilor S7